

**FICHE D'HOMOLOGATION
HOMOLOGATION FORM**

Homologation N°

20/P/19



**COMMISSION INTERNATIONALE
DE KARTING - FIA**



PNEUMATIQUE / TYRE

Manufacturier	<i>Tyre Manufacturer</i>	LeCont s.r.l.
Marque	<i>Make</i>	LeCont
Modèle	<i>Model</i>	Wet 11x6.00-5 LW
Catégorie	<i>Category</i>	Grupe 1&2 / Group 1&2
Durée de l'homologation	<i>Validity of the homologation</i>	3 ans / 3 years
Nombre de pages	<i>Number of pages</i>	4
Nombre de pages annexes	<i>Number of appended pages</i>	

La présente Fiche d'Homologation reproduit descriptions, illustrations et dimensions du pneumatique au moment de l'homologation CIK-FIA. Le Manufacturier a la possibilité de les modifier seulement dans les limites fixées par le règlement CIK-FIA en vigueur.

This Homologation Form reproduces descriptions, illustrations and dimensions of the tyre at the time of the CIK-FIA homologation. The Tyre Manufacturer may modify them, but only within the limits laid down by the CIK-FIA regulations in force.



**PHOTO DU PNEU MONTÉ SUR LA JANTE
PHOTO OF THE TYRE FITTED TO THE RIM**

**DESSIN DE LA BANDE DE ROULEMENT
TREAD DESIGN DRAWING**

Signature et tampon de l'ASN
Signature and stamp of the ASN

Signature et tampon de la CIK-FIA
Signature and stamp of the CIK-FIA



V. Alude





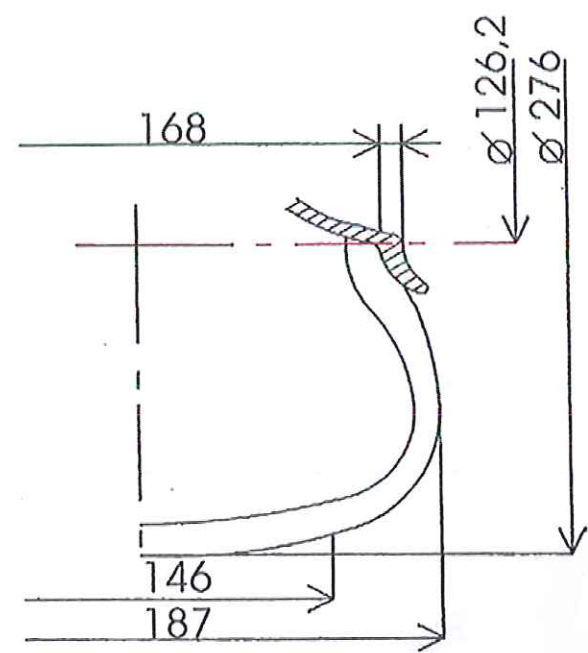

DESCRIPTIONS TECHNIQUES		TECHNICAL DESCRIPTIONS				
Sous une température de 23°C +/- 2°C, avec une humidité de 50% +/-5%		At a temperature of 23°C +/- 2°C and with a humidity of 50% +/-5%				
Pt	Descriptions	Descriptions	Valeurs		Tolérances	
1	Dimensions	Dimensions	11x6.00-5		-	
2	Désignation du mélange	Tread compound designation	LW		-	
3	Pression de service	Service pressure	0,9 bar		+/- 0,3 bar	
4	Pression de gonflage maximum	Maximum inflation pressure	4,0 bar		Max	
5	Capacité de charge maximum	Maximum load capacity	90,0 Kg		Max	
6	Vitesse maximale	Maximum speed	160 Km/h		Max	
7	Rigidité latérale et verticale (sous charge de 40 kg)	Lateral and vertical stiffness (under 40 kg load)	1,8 – 14,5		+/- 1 +/- 2	
8	Rigidité latérale et verticale pour SK et ICE (sous charge de 50 kg)	Lateral and vertical stiffness for SK & ICE (under 50 kg load)	-----		+/- 1 +/- 2	
9	Profondeur du profil	Depth of tread	5,0 mm		+/- 0,5 mm	
10	Poids en grammes	Weight in grams	1430 gr		+/- 10 %	
11	Nombre de plis	Numbers of plies	2		-	
12	Épaisseur de la bande de roulement	Tread thickness	6,0 mm		+/- 1,0 mm	
13	Nombre d'indicateurs d'usure du pneu	Number of tread wear indicators	-----		-	
14	Matériel de la carcasse	Carcass material	Nylon		-	
15	Angle de tissage de la toile du pneu	Angle of tyre canvass	30°		+/- 3°	
16	Type du fil de tissage (Selon ISO)	Canvass thread type (According to ISO)	940		-	
17	Pneu tubeless	Tubeless tyre	YES		-	
18	Dureté superficielle de la bande de roulement (ISO 48 :2010 – 2 échantillons de 2mm d'épaisseur)	Superficial tread hardness (ISO 48:2010 – 2 samples of 2mm thickness)	44.0		+/- 5 DIDC - IRHD	
19	Contrainte-déformation en traction (ISO 37:2011 – éprouvette type 3)	Tensile stress-strain (ISO 37:2011 – type 3 sample)	At 100%	At 300%	At 100%	At 300%
			-----	-----	+/- 0.5 MPa	+/- 0.8 MPa
20	Classification (selon ISO 37:2005 – 300%)	Classification (according to ISO 37:2005 – 300%)	PRIME (medium)		OPTION (hard)	

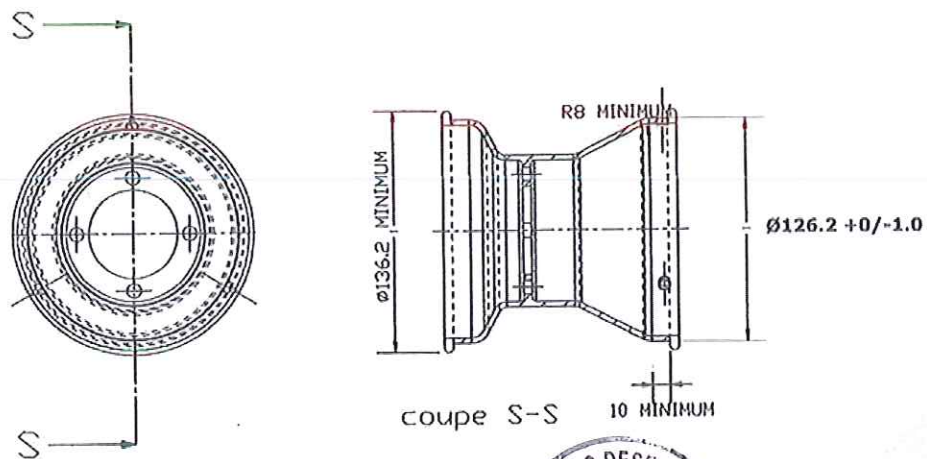

B	B																		
<p>DESSIN EN SECTION TRANSVERSALE ET MESURES DU PNEU MONTÉ SUR UNE JANTE</p> 	<p>DRAWING OF CROSS SECTION AND DIMENSIONS OF TYRE FITTED TO A RIM</p> <table border="1"> <thead> <tr> <th colspan="2">Tolérances Tolerances</th> </tr> <tr> <th>mm</th> <th>mm</th> </tr> </thead> <tbody> <tr> <td>Diam. 126,2</td> <td>+0,0 -1,0</td> </tr> <tr> <td>Diam. 276,0</td> <td>+/- 10,0</td> </tr> <tr> <td>168,0</td> <td>+/- 2,0</td> </tr> <tr> <td>146,0</td> <td>+/- 5,0</td> </tr> <tr> <td>187,0</td> <td>+/- 6,0</td> </tr> <tr> <td colspan="2">Remarques Comments</td> </tr> <tr> <td colspan="2"> </td> </tr> </tbody> </table>	Tolérances Tolerances		mm	mm	Diam. 126,2	+0,0 -1,0	Diam. 276,0	+/- 10,0	168,0	+/- 2,0	146,0	+/- 5,0	187,0	+/- 6,0	Remarques Comments			
Tolérances Tolerances																			
mm	mm																		
Diam. 126,2	+0,0 -1,0																		
Diam. 276,0	+/- 10,0																		
168,0	+/- 2,0																		
146,0	+/- 5,0																		
187,0	+/- 6,0																		
Remarques Comments																			

Jante 5" standardisée / Standardised 5" rim

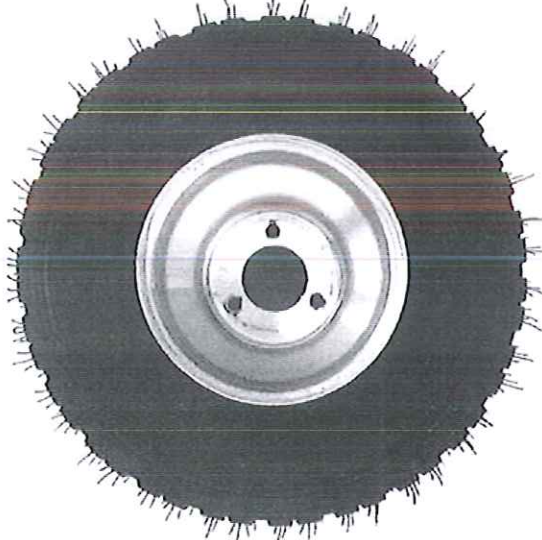

C	PHOTOS ET INSCRIPTIONS	Seules les inscriptions qui ne changeront pas tout au long de la fabrication sont reportées ci-dessous.		
C	PHOTOS AND INSCRIPTIONS	Only inscriptions which will not change during production are mentioned below.		
Photo du flanc extérieur du pneu Photo of tyre external side wall		Inscriptions sur le flanc extérieur du pneu Inscriptions on tyre external side wall		
		Texte Text	Hauteur Height	Trait Stroke
		<p>LeCONT  (Printed)</p> <p><i>11 X 6.00 - 5</i></p> <p>FOR RACING PURPOSE ONLY</p> <p>MAX INFLATION PRESSURE</p> <p>4 BAR / 58 PSI</p> <p>CIK LW</p>	11,0	0,8
Photo du flanc intérieur du pneu Photo of tyre internal side wall		Inscriptions sur le flanc intérieur du pneu Inscriptions on tyre internal side wall		
		Texte Text	Hauteur Height	Trait Stroke
		<p>LeCONT </p> <p><i>11 X 6.00 - 5</i></p> <p><i>TUBELESS</i></p> <p>FOR RACING PURPOSE ONLY</p> <p>MAX INFLATION PRESSURE</p> <p>4 BAR / 58 PSI</p> <p></p>	18,0	1,5 / 3,5